

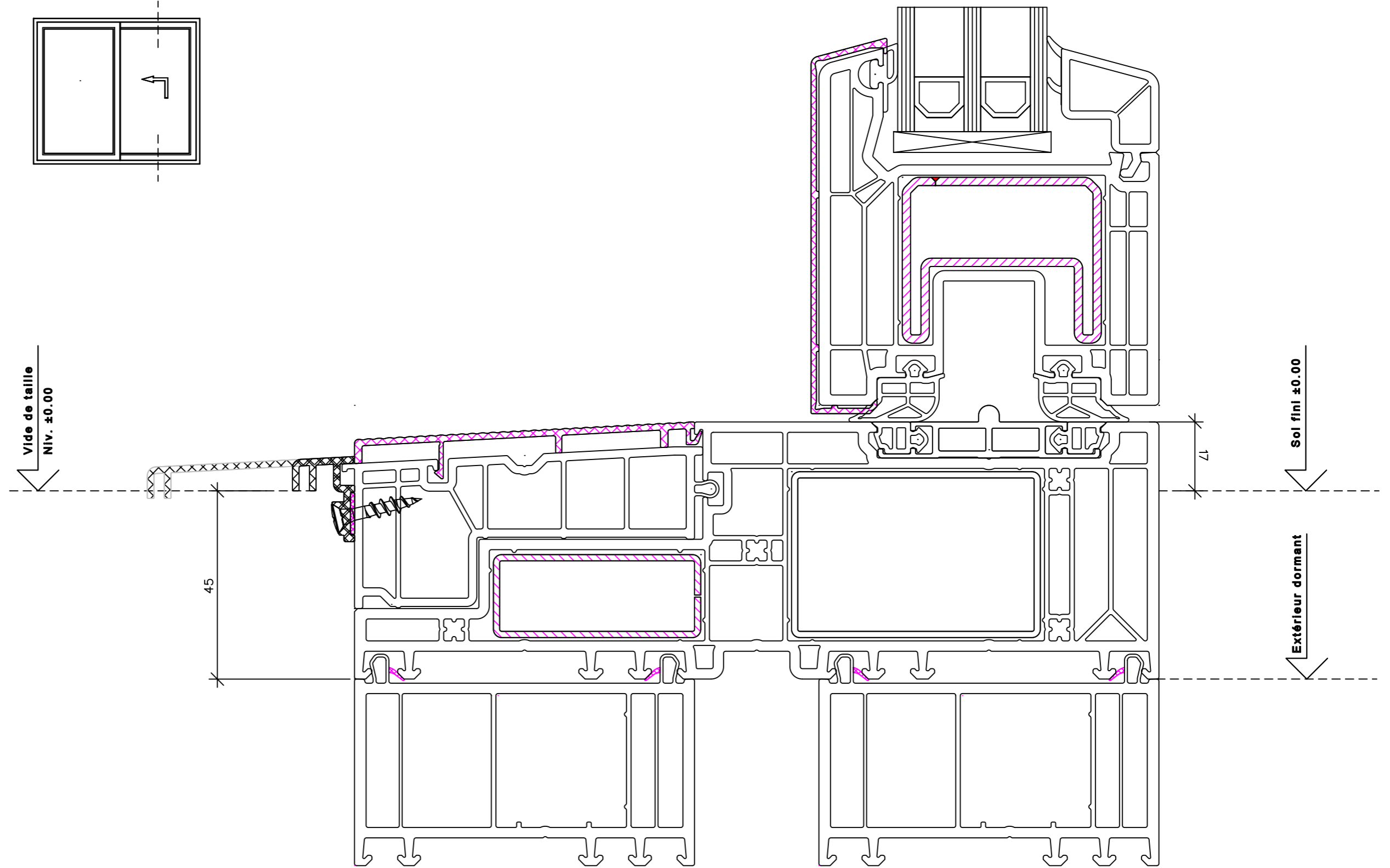

SCHEMA A

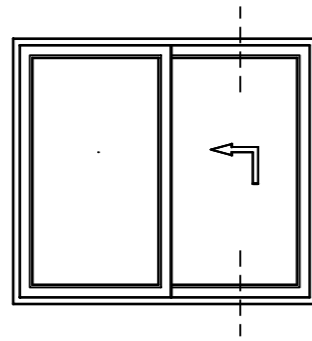

VekaMotion - aluminium

Seuil Exotherm 105.422

Vantail 105.421

Echelle
1:1

20.12.2022

Motion-8100AbHS



SCHEMA A

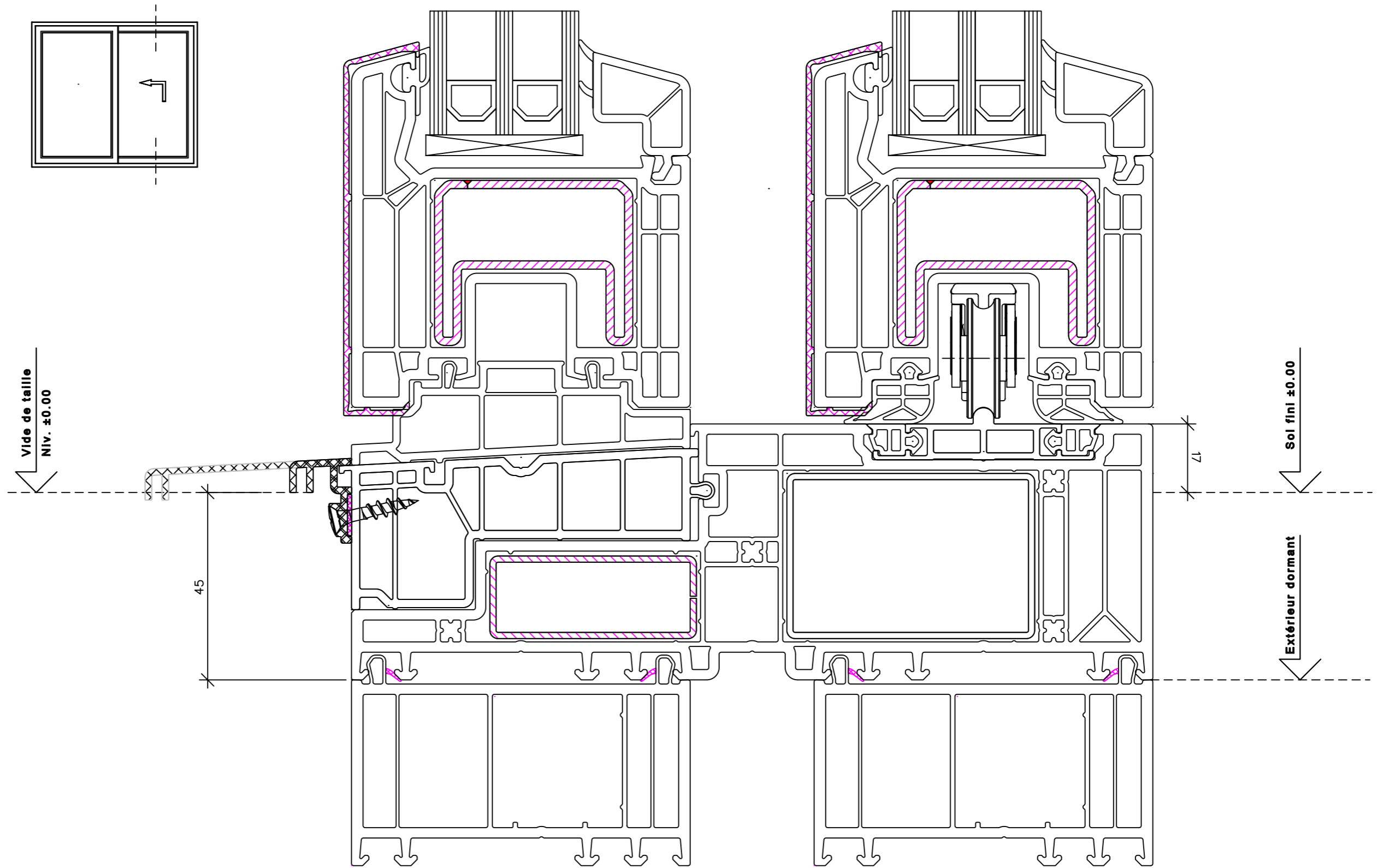

VekaMotion - aluminium

Seuil Exotherm 105.422

Vantail 105.421

Echelle
1:1

20.12.2022

Motion-8100Ab2HS



SCHEMA A

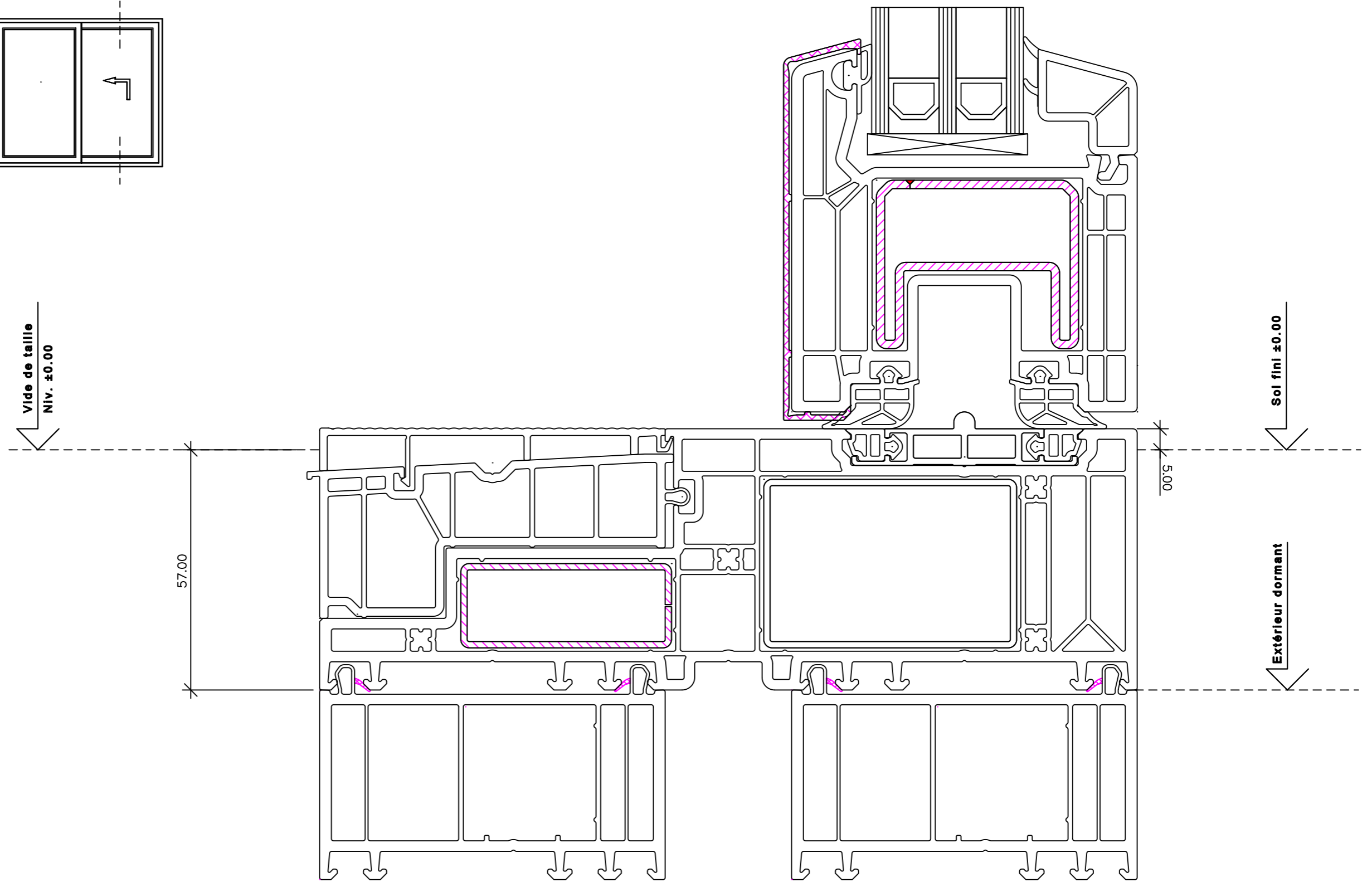
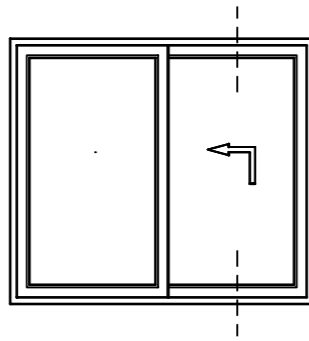

VekaMotion - aluminium

Seuil Exotherm 105.422

Vantail 105.421

Echelle
1:1

20.12.2022

Motion-8101AbHS

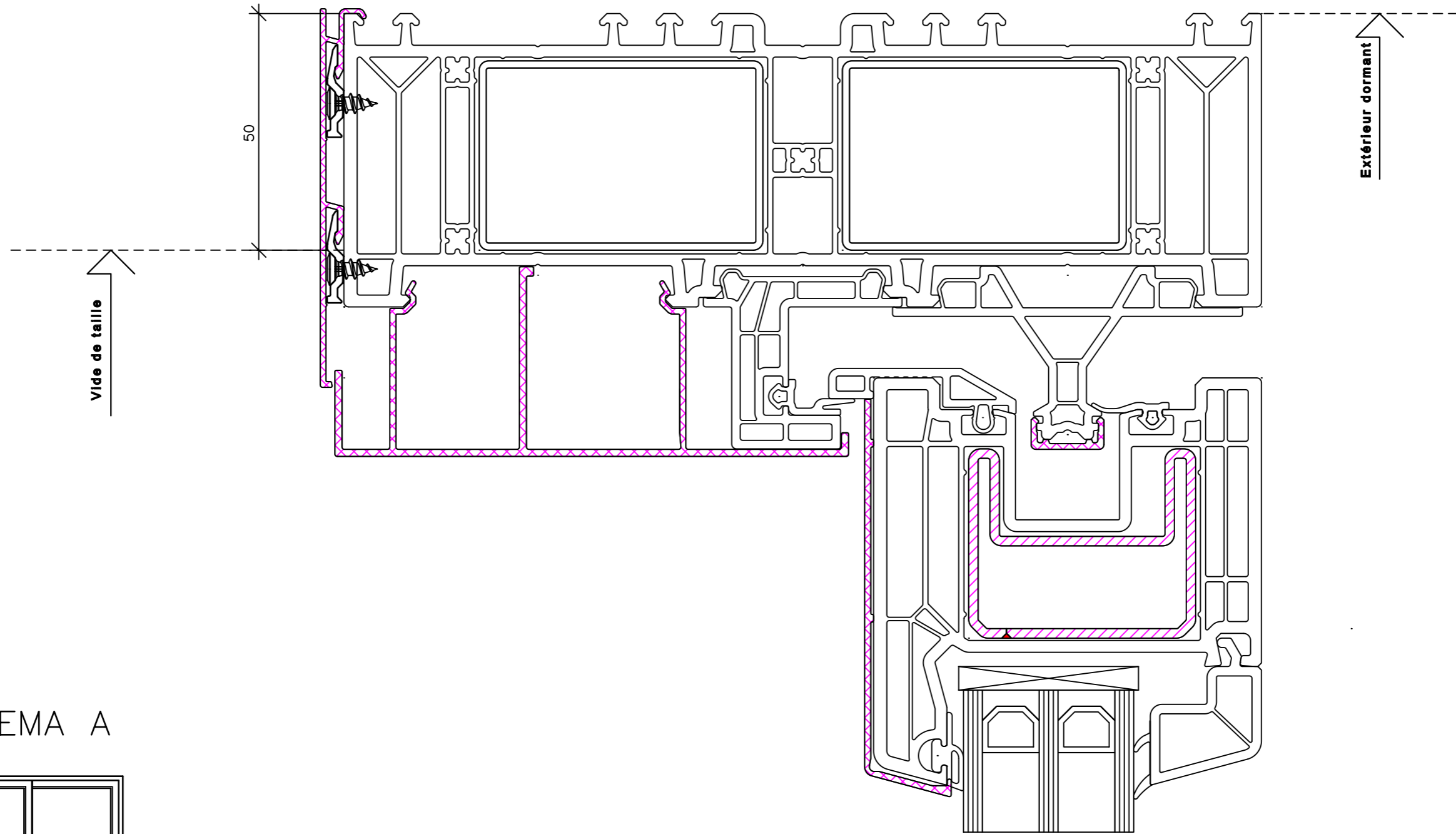

SCHEMA A

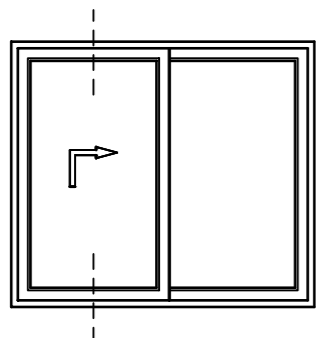

VekaMotion - aluminium

Dormant 105.420
Vantail 105.421

Echelle
1:1

20.12.2022

Motion-8110AHS

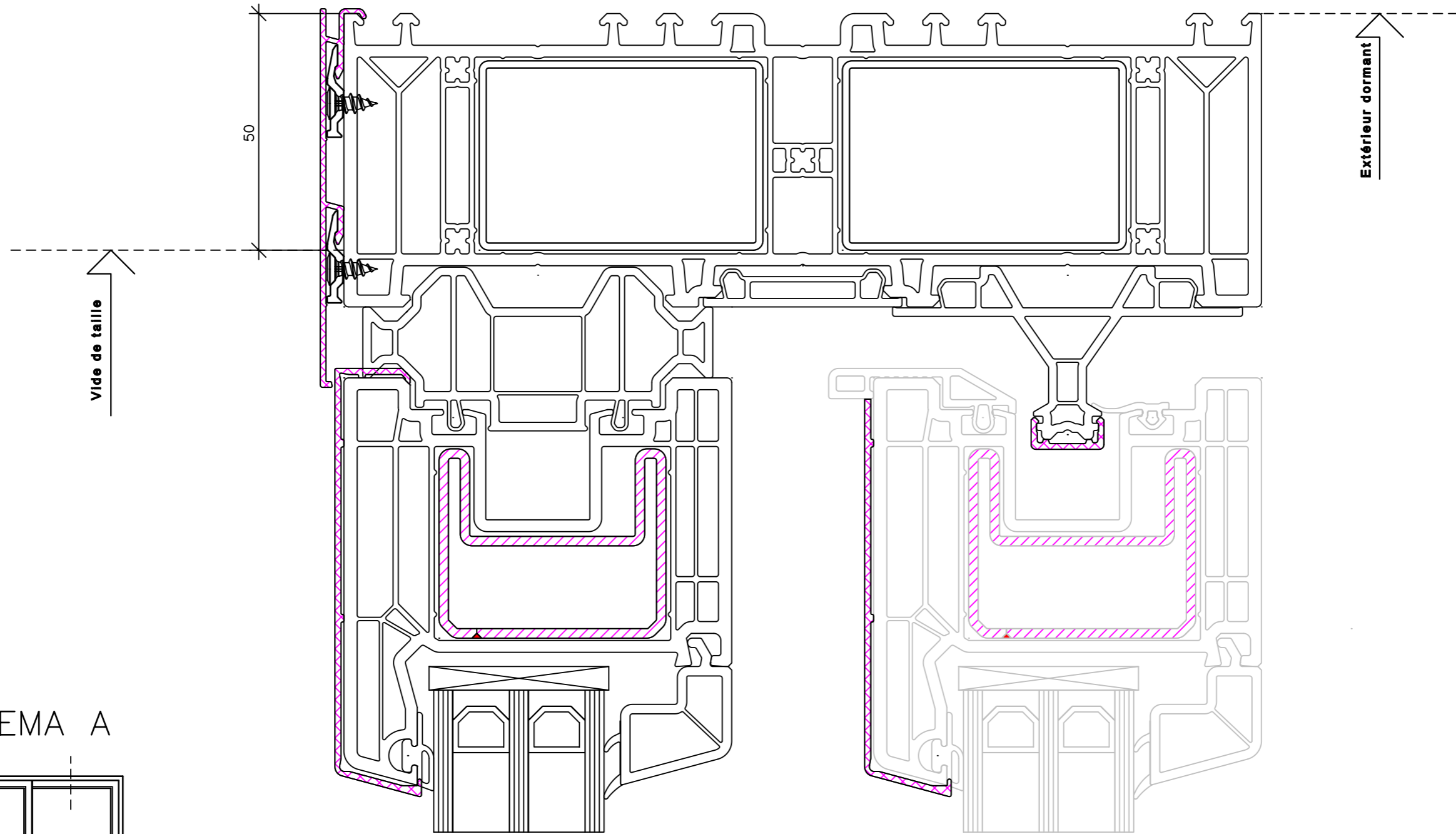

SCHEMA A

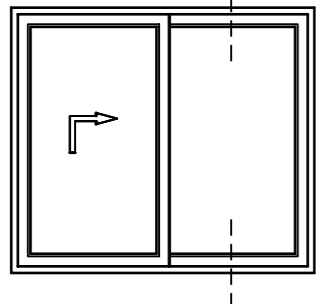

VekaMotion - aluminium

Dormant 105.420
Vantail 105.421

Echelle
1:1

20.12.2022

Motion-8111AHS

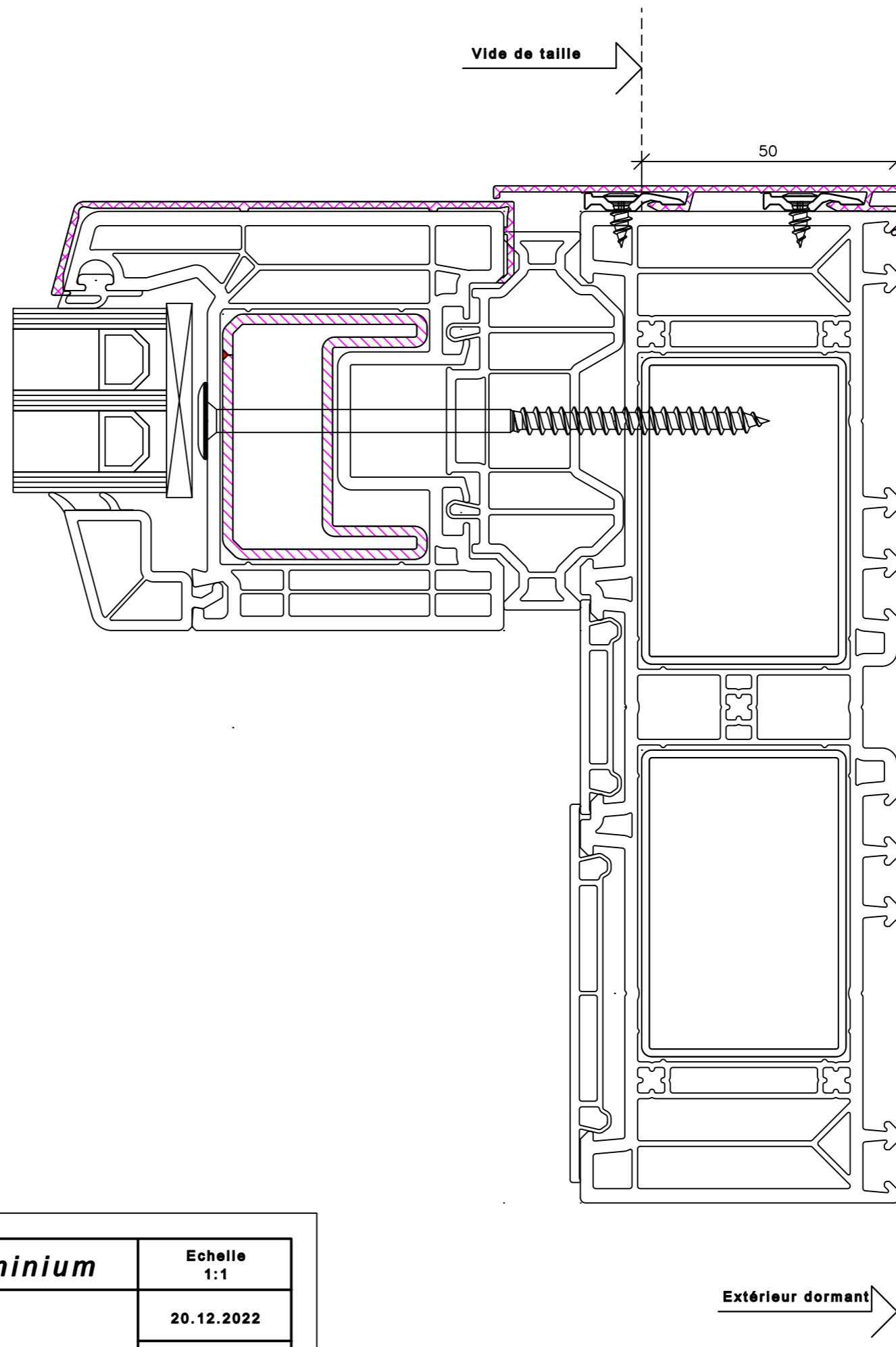

VekaMotion - aluminium

Dormant 105.420
Vantail 105.421

Echelle
1:1

20.12.2022

Motion-8120AHS

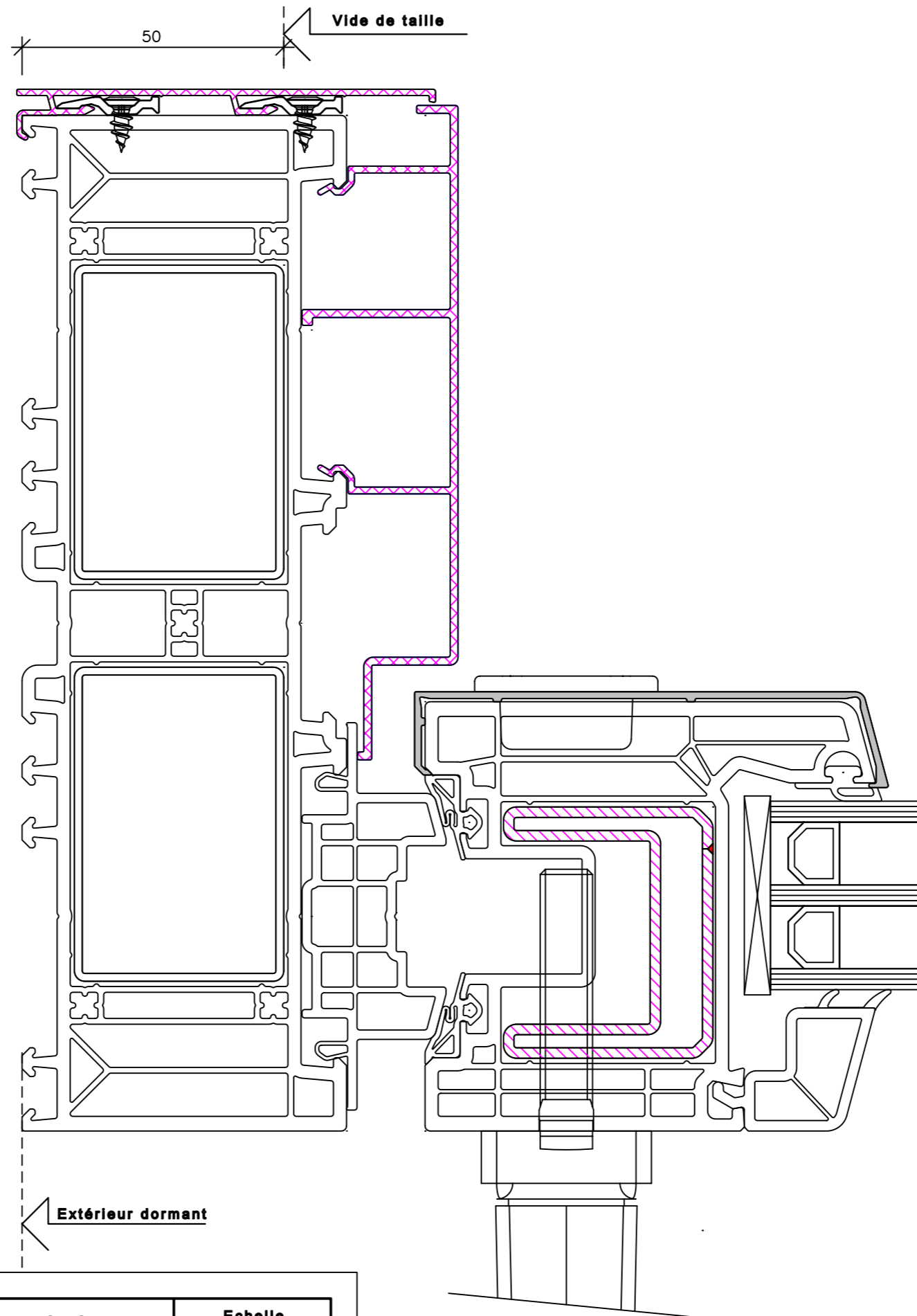

VekaMotion - aluminium

Dormant	105.420
Vantail	105.421

**Echelle
1:1**

21.12.2022

Motion-8121AHS

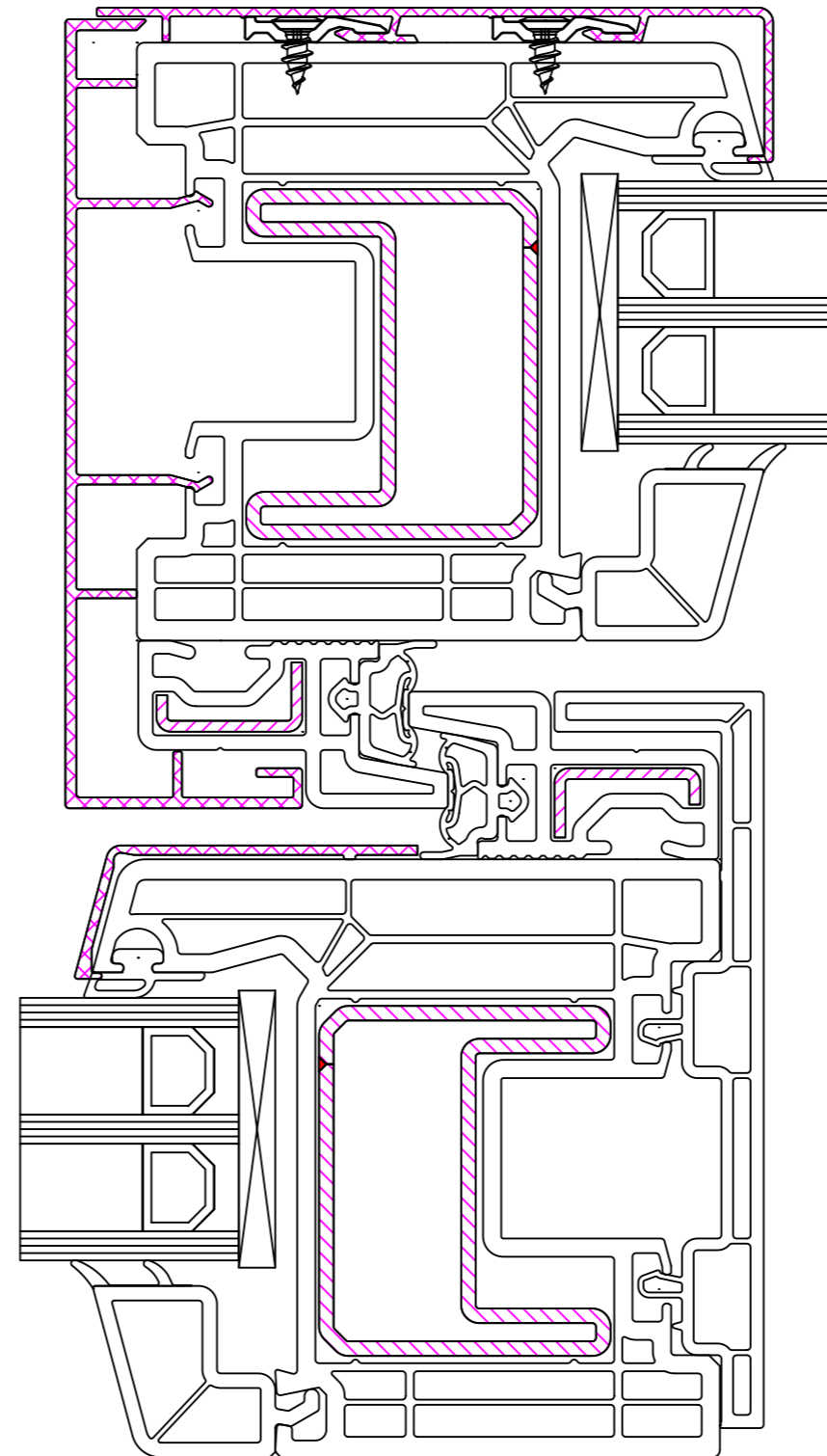

SCHEMA A

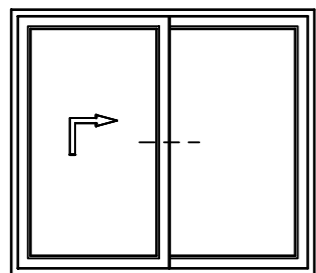

VekaMotion - aluminium

Dormant 105.420
Vantail 105.421

Echelle
1:1

21.12.2022

Motion-8130AHS

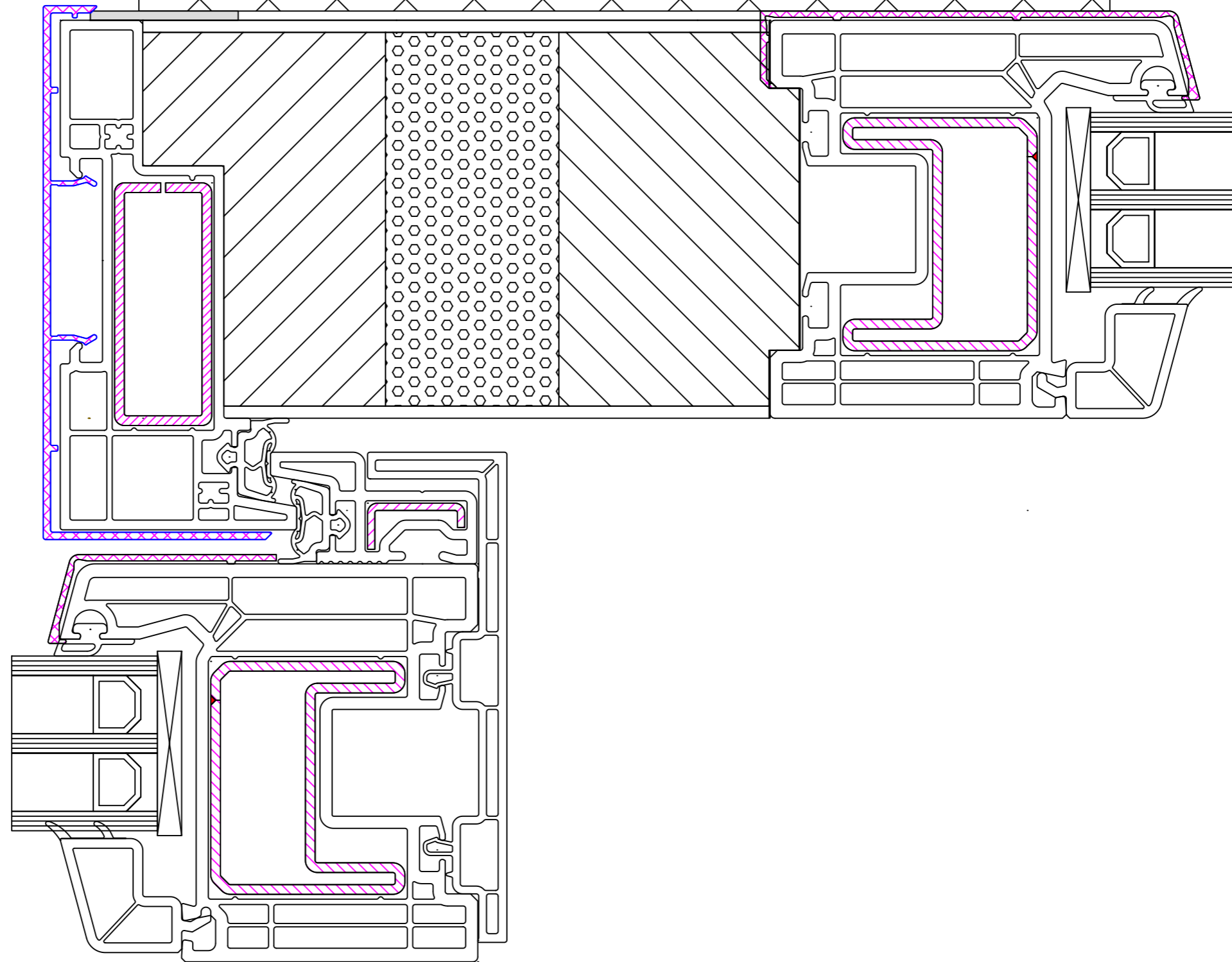

SCHEMA A

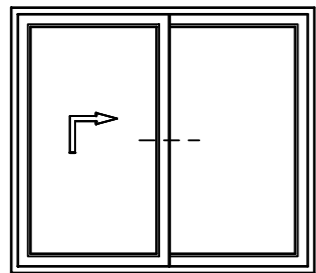

VekaMotion - aluminium

Dormant 105.420
Vantail 105.421

Echelle
1:1

02.02.2023

Motion-8130AHS
Poteau